

ELECTRIC ACTUATOR SET

for 1/14 SCALE R/C TIPPER TRUCK

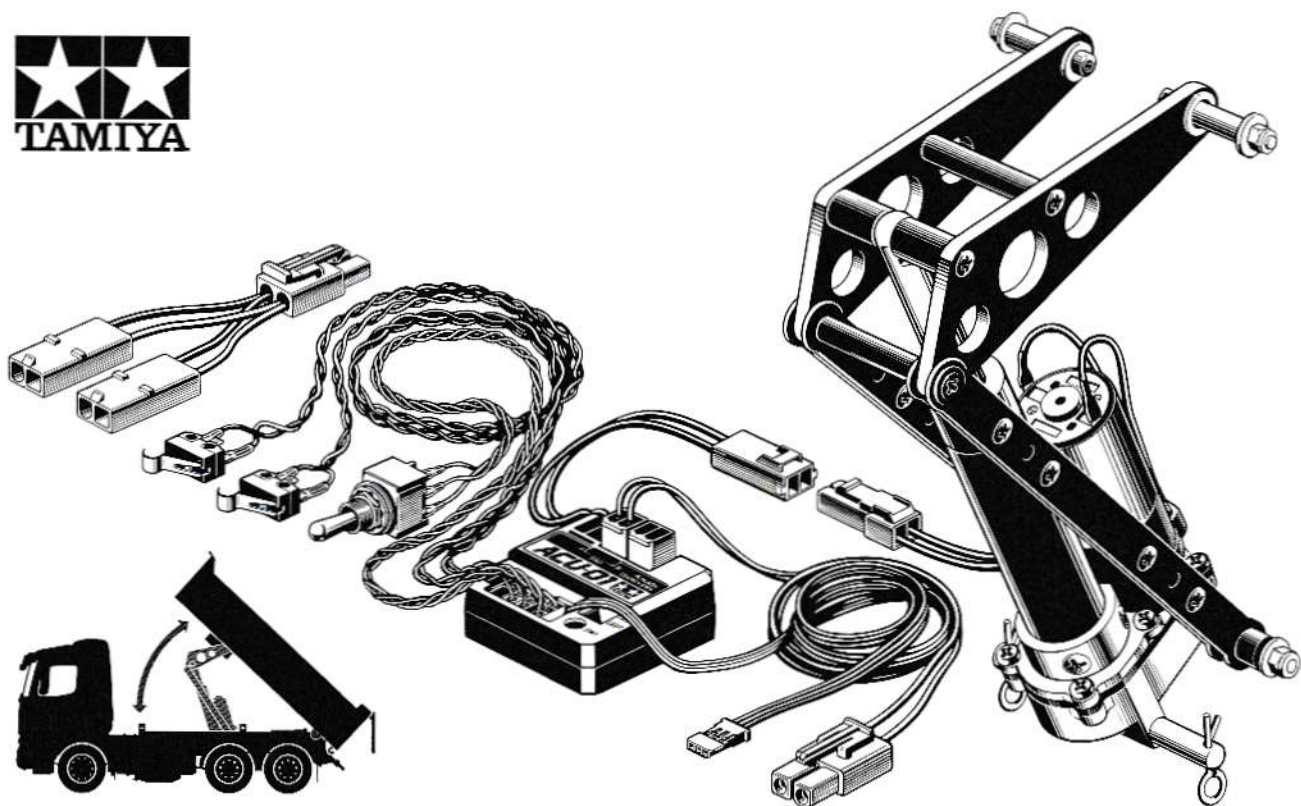

⚠ CAUTION

- When assembling this kit, tools including knives are used. Extra care should be taken to avoid personal injury.
- Keep out of reach of small children when assembling. Children must not be allowed to touch tools or put any parts or packaging material in their mouths.

《Before assembly》

- Thank you for purchasing this Tamiya Actuator Set product. Check the set contents before assembly. Please contact your local Tamiya dealer if any defect or missing part is found.
- Read carefully and fully understand this instruction manual before beginning assembly.
- This product is for use with Tamiya R/C tipper truck models, and allows control of truck bed motion. It cannot be used together with Motorized Support Legs (Item 56505). It is compatible with MFC-01 and MFC-03 Multi-Function Control Units (recommended), plus ESCs usable with Tamiya R/C tractor trucks.

《R/C System》

- This kit requires the following items (not included in this kit); a 4ch transmitter (self-neutral stick type with 4ch trims), a 4ch receiver, 2 servos and either an ESC, MFC-01 or MFC-03 (accurate as of December 2017).
- When using with MFC-01 or MFC-03, 2ch or 3ch R/C units cannot be used.
- FINESPEC 2.4G 4ch TTU-09 / TRU-09, Futaba ATTACK 4WD

T4VWD / FP-114H or Futaba ATTACK 4YWD-2.4G / R204 GF-T are recommended for optimum operation.

★ Digital servos and hi-torque servos (such as Items 45061, 45062 and 45065) may impair function.

※ If using MFC-01 or MFC-03, ensure that R/C system is compatible with it.

※ If unsure as to compatibility, please contact your local Tamiya agent.

● When using R/C units other than those listed above, use only self-neutral stick type transmitters with 4ch sliding type trim levers. Transmitters which do not employ a self-neutral system or sliding type trim levers (e.g. click-touch type trims) may not realize optimum operation.

● R/C units from makers other than those listed above may operate, but some functions may not be usable and performance may be less than optimal. The signal may also differ, so those above are strongly recommended.

● PCM units, multi-channel units, and those with different signal distributions or multiple signals per channel cannot be used with this kit.

● Use only TR mighty-tuned motor (35T), or Tractor Truck Option Parts series motors for truck model.

● Some receiver connectors may not be compatible and require modification or use of conversion cable.

● Only for use with Tamiya 7.2V or 6.6V battery packs. Batteries with higher voltage may damage the unit and void warranty.

《Actuator Control Unit (ACU-01)》

- Transforms transmitter/manual controls into commands to ACU motor.
- ACU motor (2435BK64) controls raising/lowering of truck bed.
- Truck bed weight limit: 10kg. This figure applies to evenly-distributed loads. Uneven or overhanging loads may cause damage or model to stop functioning even when under 10kg.

※MFC-01/MFC-03/ESC

- See instruction manual with equipment regarding other functions and related units.

●The ACU motor can operate continuously for up to 60 seconds, and will automatically stop after that period.

※Use only TR mighty-tuned motor, or Tractor Truck Option Parts series motors for truck model. Other Type 540 motors may not provide sufficient control and should not be used.

※Power source

●Shared with model battery pack.

●Only for use with Tamiya 7.2V or 6.6V battery packs.

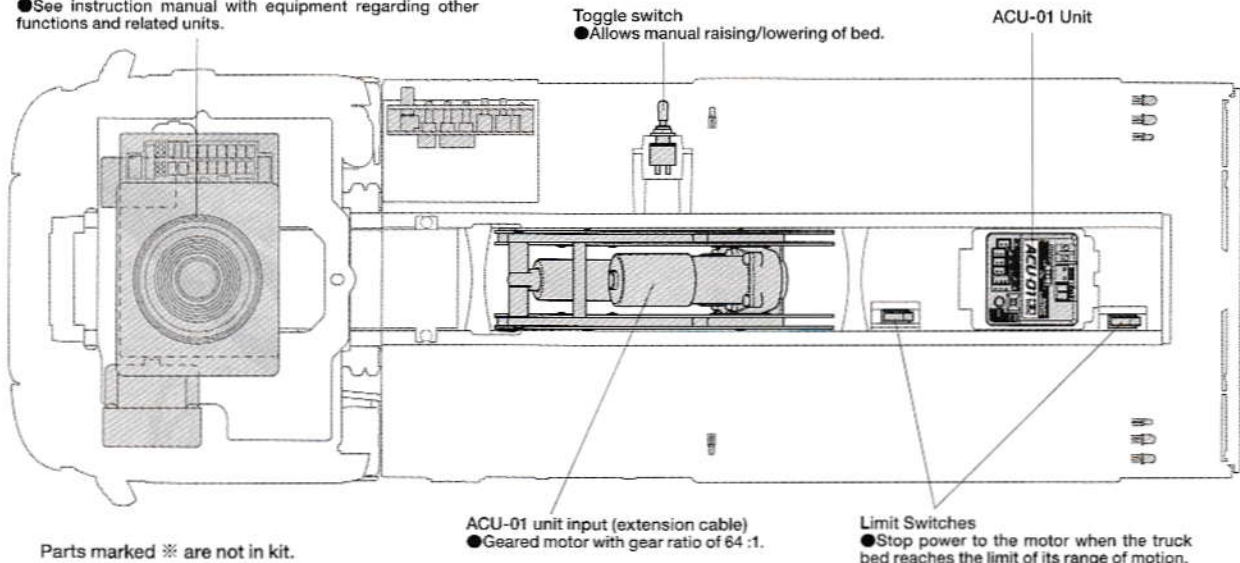

《Connecting cables ① - ESC》

- ★Be careful to attach units and cables properly.
- ★Always disconnect battery when attaching or detaching connectors.
- ★When disconnecting cables, hold connectors with long nose pliers and pull out carefully. Be careful not to hold the connector too tightly.
- ★Never connect receiver battery (6V). It may damage the unit.

※Some ESCs do not have low voltage protection. In such a case, the ACU-01 protection functions will stop it before ESC cut-off if in standard mode.

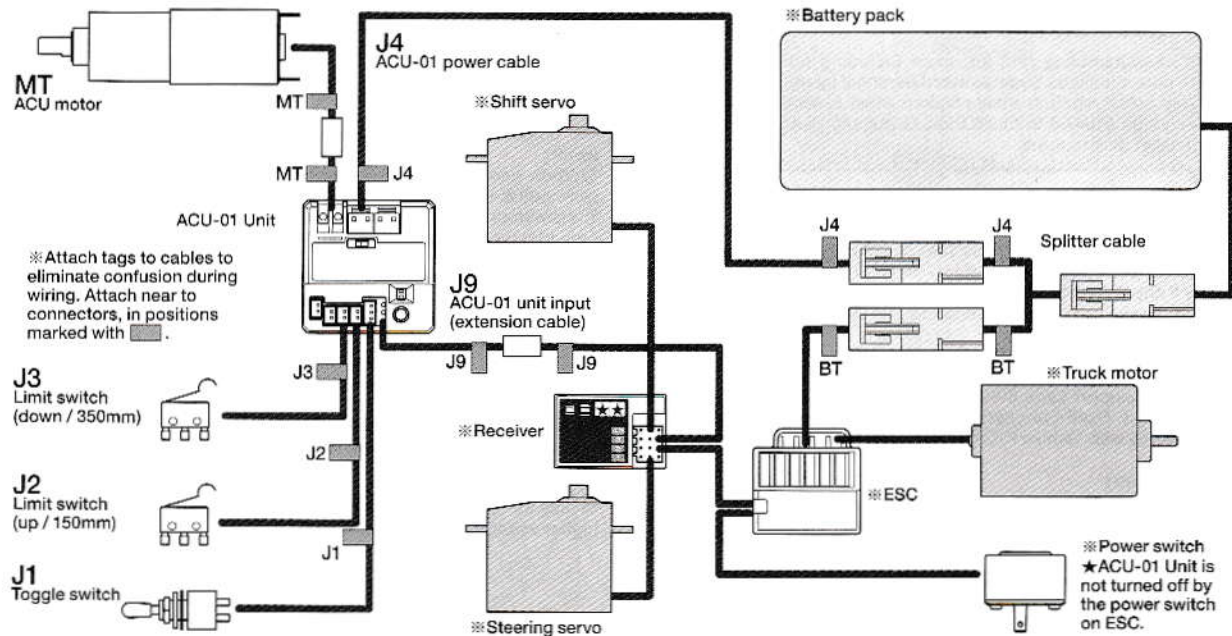
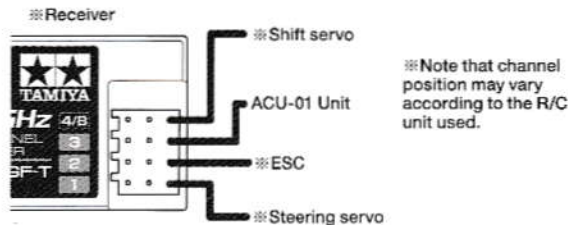

《Connecting cables ② - MFC-01/MFC-03》

- ★Be careful to attach units and cables properly.
- ★Always disconnect battery when attaching or detaching connectors.
- ★When disconnecting cables, hold connectors with long nose pliers and pull out carefully. Be careful not to hold the connector too tightly.
- ★Never connect receiver battery (6V). It may damage the unit.
- ★Note connector numbers.

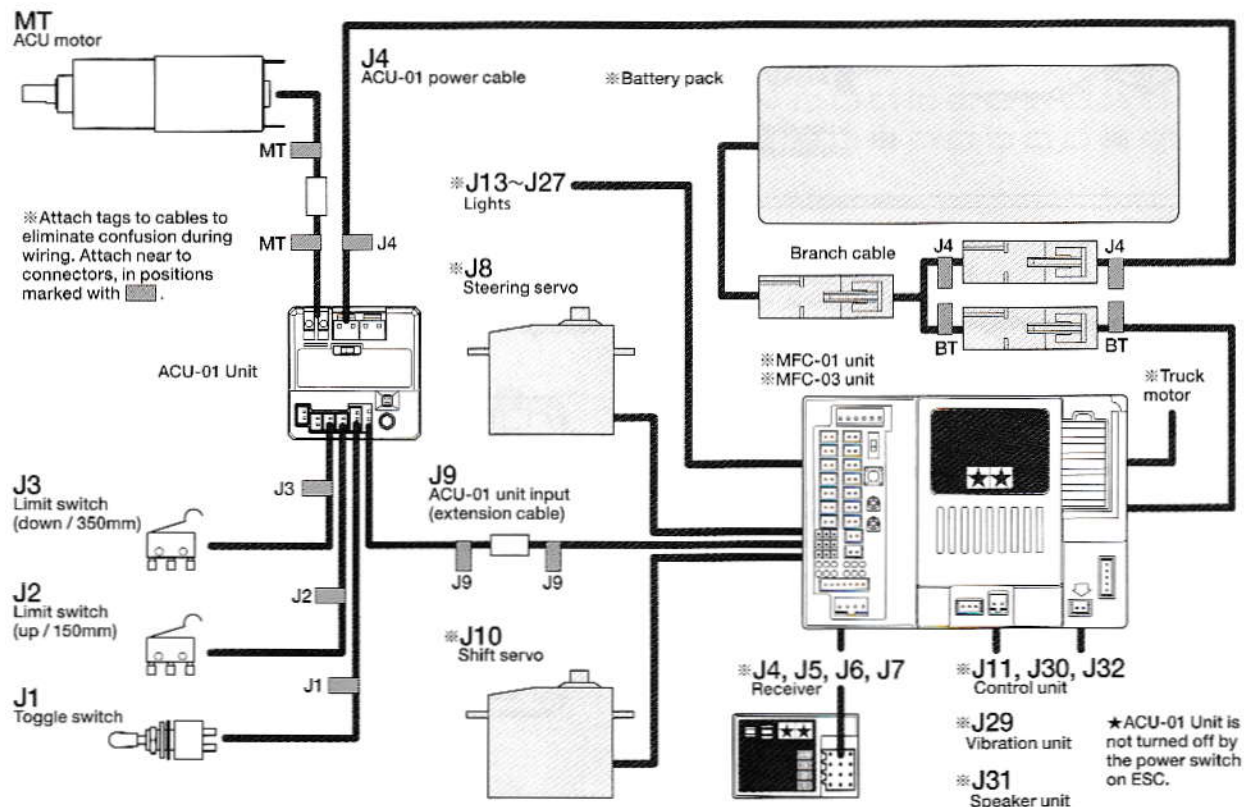
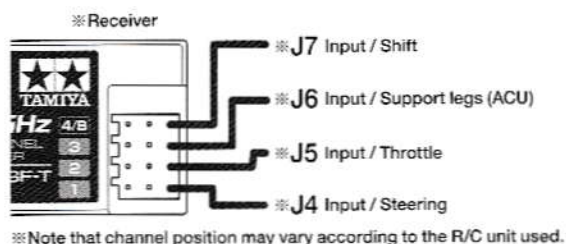

《ACU-01 Unit》

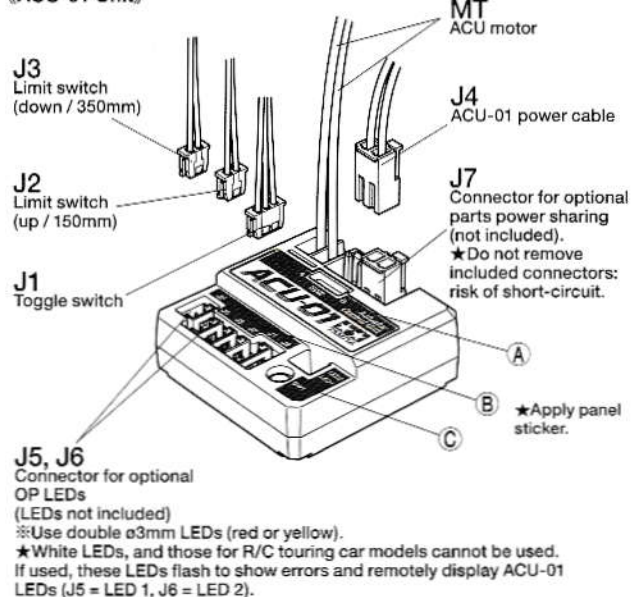

《※MFC-01 unit / ※MFC-03 unit》

- ※Remove MFC-01/MFC-03 coupler switch connector from J12 and replace with J12 jumper wire.
- ※Always connect J12 jumper wire. Failing to do so will limit motor output, potentially affecting truck performance when it is carrying heavier loads.

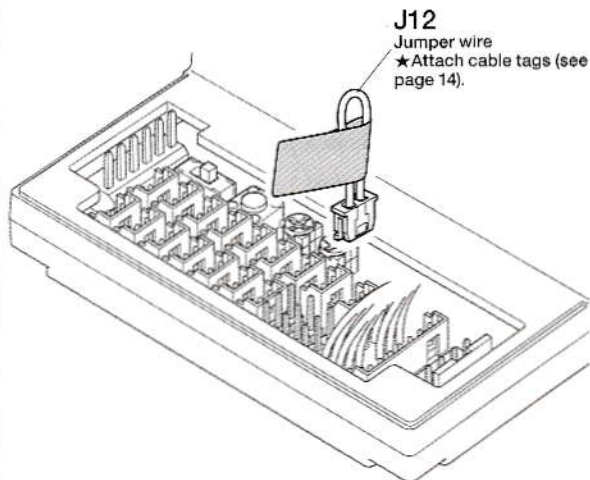

《Attaching cable tags》

● Attach tags to cables to eliminate confusion during wiring.

★ Connectors are of the same shape. Be careful not to confuse them when attaching tags.

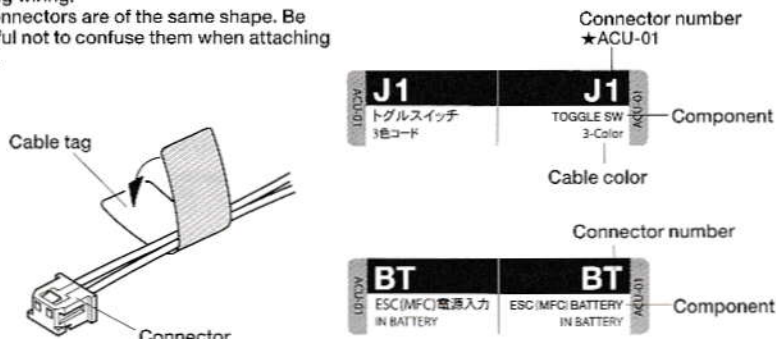

★ Use spare cable tags for extension cables and the like.

J1	Toggle switch (3-color cable)
J2	Limit switch (up) (Grn-Gra cable)
J3	Limit switch (down) (Grn-Bla cable)
J4	ACU-01 power cable
J5 (OP①)	ø3mm LEDs (red/yellow)
J6 (OP②)	ø3mm LEDs (red/yellow)
J7	ACU-01 power output (OP)
J9	ACU-01 signal output
J12	Jumper wire (Grn cable)
BT	ESC/MFC unit power cable
MT	ACU-01 motor

《ACU-01 Unit Functions & Adjustment》

● SW1 - Set switch

SW1 is used during teaching, dead band adjustment, re-initialization of the ACU-01 unit, and changing power mode.

• Power mode selection: choose between 3 modes with different voltage level protection functions. See page 15.

• Teaching: ensure that ACU-01 correctly receives and carries out command from transmitter.

● SW2 - Motor output adjustment switch

Changes between unit standard motor and optional motor output levels. Ensure that A is selected when using this product.

• A: For use when employing ACU-01 with ACU motor, position A controls toggle switch, limit switches and LEDs 1 and 2. The ACU-01 will only work in this position if limit switches are correctly connected and in working order.

• B: For use with potential future product evolutions, this position allows operation without limit switches. NEVER put this switch onto position B when using with this product, as it will cause damage to the model.

● LED 1 (red)

● LED 2 (green)

See page 19 for details about LED.

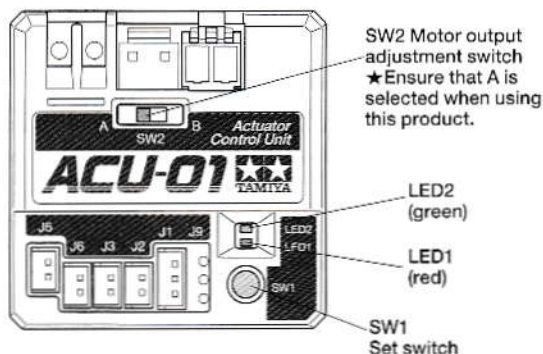

《Power source》

● While the ACU-01 Unit does not have a power switch, it is designed to analyze usage and conserve battery power where possible.

● Disconnect battery pack to turn off ACU-01 when it is not in use.

● Toggle switch remains live if battery is connected. Always disconnect battery when not using.

● Leaving battery pack connected for long periods when ACU-01 Unit is not in use can lead to over-discharging and damage.

● ACU-01 Unit will sleep to avoid over-discharging if battery pack voltage is low. Connect a fully-charged battery pack to resume usage.

● ACU-01 Unit is not turned off by the power switch on MFC-01/MFC-03/ESC. Disconnect battery pack to turn off ACU-01.

● ACU-01 Unit will not operate without Ch.3 receiver signal, connected limit switches and the connection of a sufficiently-charged battery (varies according to power mode).

● LEDs 1 and 2 will light up when ACU-01 Unit is on. If J5 and J6 LEDs are connected, they will light up and flash to show LEDs 1 and 2 remotely.

《Power mode》

● Different power modes can be set depending upon the type of battery pack used. Please note that these modes do not prevent over-discharging, but activate a series of protection functions in the following order:

1. Alarm ①: ACU-01 operational
2. Alarm ②: ACU-01 not operational
3. Sleep

Please note that some power modes may skip one or both warnings.

● This product is designed for use with MFC-01 or MFC-03 Multi-Function Control units. It will continue to function at input voltage levels below MFC unit's low voltage protection cut-off.

● Some ESCs do not have low voltage protection. In such a case, the ACU-01 protection functions will stop it before ESC cut-off.

● This product is designed for use with Tamiya battery packs. Use with other products may void warranty.

3 power modes are selectable: 1. Standard mode (Tamiya battery pack), 2. R6/AA/UM3 battery mode, and 3. Battery failsafe mode. Use 1. Standard mode with this product.

《Changing modes》

Press SW1 three times inside 2 seconds. LEDs flash to show selected mode.

Standard mode (Tamiya battery pack)

↓

R6/AA/UM3 battery mode

↓

Battery failsafe mode

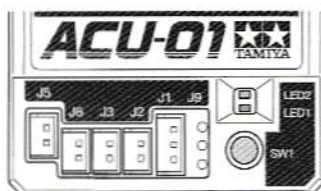

《Power mode》

●Standard mode (Tamiya battery pack)

This mode is for use with 6.6V – 7.2V Tamiya LF and NiCd battery packs. It features 2 alarm stages before going to sleep.

Alarm ① (ACU-01 operational) (LED signal)

- ※Alarm tone ① sounds quietly, but truck bed still moves.
- ※Alarm stops if voltage returns to sufficient levels.

Alarm ② (ACU-01 not operational) (LED signal)

- ※Alarm tone ② sounds quietly, and truck bed does not move.
- ※Alarm stops and bed can move if voltage returns to sufficient levels.

Sleep (LED signal)

- ※Truck bed does not move. No alarm tone is emitted.
- ※Unit will remain in sleep mode even if voltage returns to sufficient levels. Disconnect connectors and connect a fully-charged battery to resume use.

★Selected mode is displayed by flashing of LEDs.

●R6/AA/UM3 battery mode

This mode is for use when using four R6/AA/UM3 batteries as a 4.8V-6.0V power source, when employing ACU-01 with optional parts other than actuator motor. This mode is not for use with this product.

Alarm ①, alarm ② and sleep mode occur as described for the standard mode (please note that the voltage at which each protection function occurs will differ).

●Battery failsafe mode

This mode puts the ACU-01 unit to sleep immediately when MFC unit low protection function is engaged. Do not use stop mode for this product.

★To deactivate alarm and protective functions, allow voltage to recover, or use toggle switch to manually operate truck bed. If protection functions (alarms, etc.) continue, remove connectors and restart ACU-01.

《Transmitter commands》

- ACU-01 Unit is operated on Ch.3.
- Other channel functions are dictated by any connected separate units. Refer to the relevant instruction manuals.
- If using with MFC-01 or MFC-03, select ACU-01 Unit using procedure for 4ch special (Support leg/Horn switching). Repeat to deselect ACU-01 Unit.
- When using with an ESC, or with an MFC unit in R/C mode, bed can be controlled without switching using procedure for 4ch special (Support leg/Horn switching).
- ACU-01 Unit will not turn on without Ch.3 receiver signal, connected limit switches and the connection of a sufficiently-charged battery.

★Keep trims in neutral position.

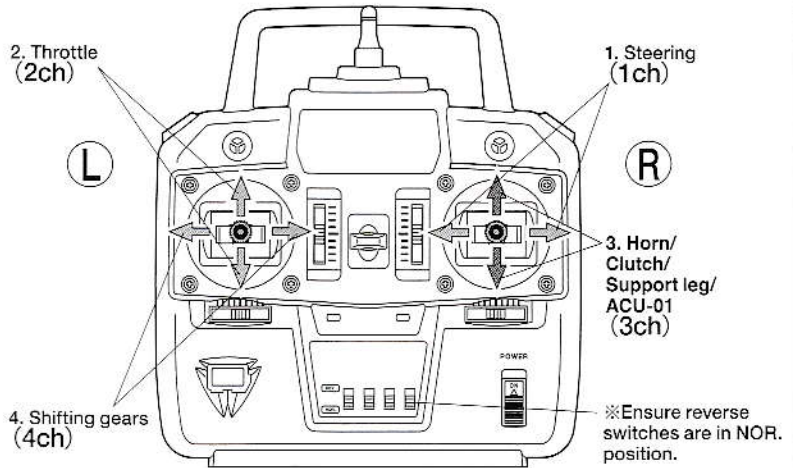

《ACU-01 Unit Adjustment (Teaching)》

★Install ACU-01 unit on model before teaching.

●As all R/C transmitters can have slight variances in performance, it is essential to perform teaching, particularly when using the ACU-01 Unit for the first time, or employing a new transmitter.

●Teaching requires the included screwdriver. Connect cables and ensure ACU-01 Unit is functioning, then set transmitter reverse switches to positions defined in the truck model instruction manual. Set trims to neutral positions.

●Two teaching modes exist:
A : Transmitter teaching (control stick operation range)
B : Trim teaching (trim operation range)

●When using with ESC, connect cables, check reverse switch and trim positions (see above), then perform teaching.

●When using with MFC-01/MFC-03, first perform teaching as described in MFC unit instruction manual.

●When MFC unit teaching is complete, connect cables to ACU-01 Unit, check reverse switch and trim positions (see above), then perform teaching.

●Perform teaching mode A first, then B.

●Current teaching mode is indicated by flashing of ACU-01 LEDs.

●When using with MFC-01/MFC-03, move MFC unit select switch into R/C mode (lowest position).

Teaching can also be performed with the select switch in Multi mode (middle position): in such a case, ensure the throttle is active and select support leg mode using procedure for 4ch special (Support

leg/Horn switching) before teaching.

●Some manufacturers' transmitters may require different reverse switch positions.

●Ensure steering and shift servos are in neutral position, adjusting rod length where possible.

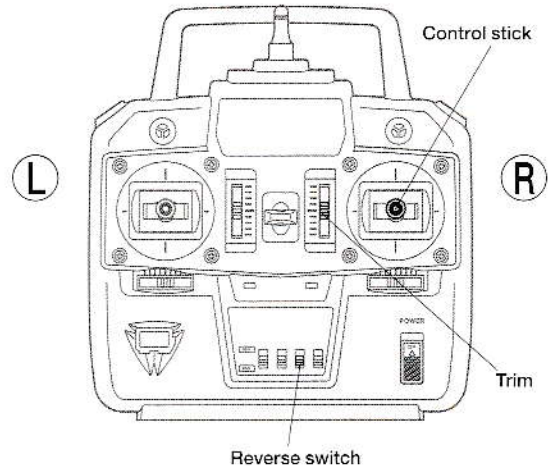
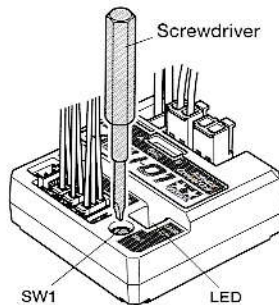

★ACU-01 teaching is a separate process to MFC unit teaching, and should always be performed.

★Repeat this process if teaching is unsuccessful. If problems persist, re-initialize following the instructions for d: Re-initialize below, then perform teaching again.

《a: Transmitter Teaching》

①Hold down SW1 for between 3 and 5 seconds, until LED 1 (red) flashes slowly, then release.

②Move control stick 2 (ch.3) from top to bottom.

③LED 2 (green) will flash slowly when signal has been correctly received.

④Press SW1 again. LED 2 will light up to signify completion of transmitter teaching.

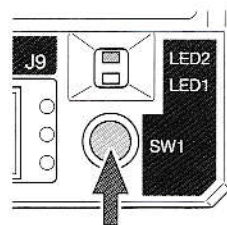
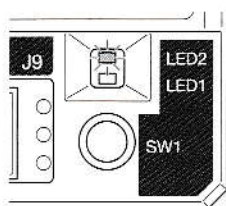
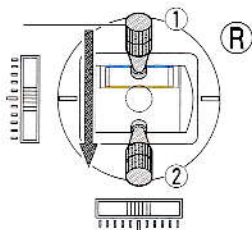
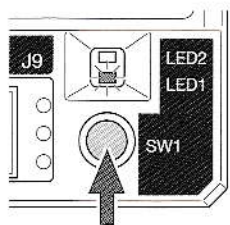

《b: Trim Teaching》

①Hold down SW1 for between 5 and 10 seconds, until LED 1 (red) double flashes slowly, then release.

②Move ch.3 trim lever from top to bottom.

③LED 2 (green) will flash slowly when signal has been correctly received.

④Press SW1 again. LED 2 will light up to signify completion of trim teaching.

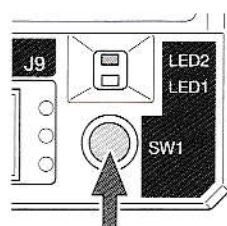
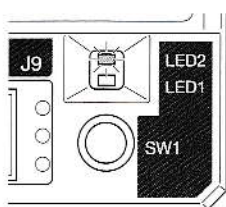
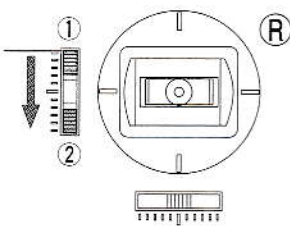
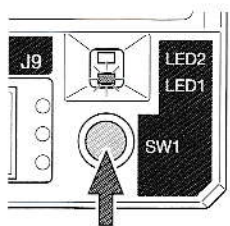

《c: Adjusting dead band》

①Hold down SW1 for 10 seconds to switch between setups. LEDs long flash alternately to signify standard setup, and double flash alternately to signify wider dead band setup. Only use wider setup if truck bed does not offer a full range of movement.

LEDs long flash alternately to signify standard setup.

LEDs double flash to signify wider dead band setup.

★After changing dead band setup, always perform teaching a and b.

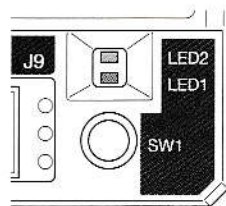
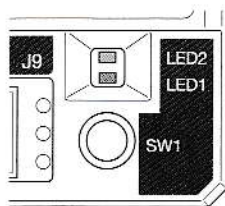
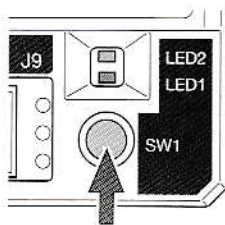

《d: Re-initialize》

①Hold down SW1 and connect battery, then release SW1. LEDs will flash, and then LED 2 will light up to signify re-initialization.

★After re-initialization, always perform teaching a and b.

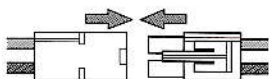
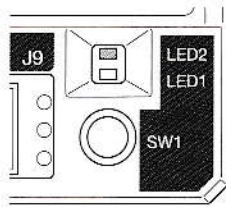
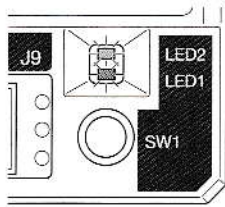
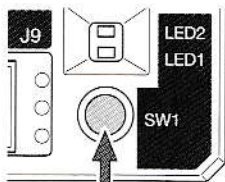

《ACU-01 Unit Specifications》

- Voltage: 6.6-7.2V (※or 4.8-6.0V according to switch position)
- Operational temperature range: -10°C to 50°C
- Store at: -20°C to 60°C
- Maximum motor current: 5A
- Compatible motors (ACU-01 Unit): Geared actuator motor (2435BK64)

- Compatible motors (truck model): TR mighty-tuned motor (35T), or motor from Tractor Truck Option Parts series. (※Other motors may cause frequent activation of protection function, and malfunction).

《Transmitter commands》

- Truck bed motion can be controlled via 4ch transmitter.
- Before operation, ensure that all external components are connected and switches in the correct position. If using with MFC-01 or MFC-03, select support leg mode using procedure for 4ch special (Support leg/Horn switching), and ensure engine is running.
- If transmitter commands do not operate truck bed correctly despite checking all connections and ACU-01 Unit again, contact your local Tamiya agent for assistance or repair.
- Truck bed motion can also be controlled via toggle switch.

★ Do not overload the truck bed, as it can prevent motion at low speeds.

※ If separately-sold $\phi 3$ mm LEDs (red or yellow) are connected to OP LED 1 and 2 ports on ACU-01 Unit, they also flash as a warning during raising/lowering of truck bed. Attach as you like. Please note that white LEDs cannot be used.

★ Full range of bed motion takes approximately 50 seconds when using a 7.2V battery. The actuator motor can operate continuously for up to 60 seconds, and will automatically stop after that period.

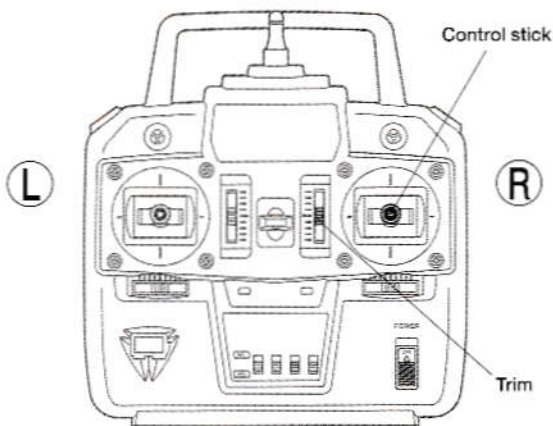

《When using ESC》

※ 3 speeds are available, according to transmitter control stick position.

- ① Raising truck bed
- ② Lowering truck bed

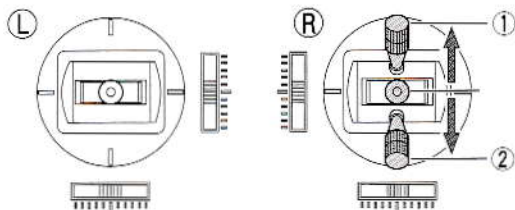

《When using MFC-01》

※ Select support leg mode using procedure for Horn / Support legs switching via transmitter.

※ Truck bed cannot be moved when model is in simulated engine stop.

● Set MFC unit to multi mode. If using R/C mode, follow instructions for using with ESC.

※ 3 speeds are available, according to transmitter control stick position.

- ① Raising truck bed
- ② Lowering truck bed

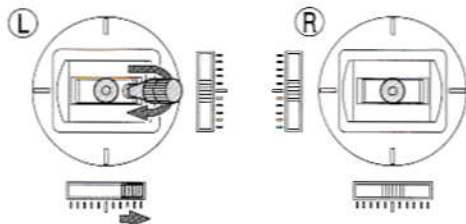

● Move 4ch trim fully to the right. Moving control stick 1 fully to the right changes mode. Use control stick 2 (Ch.3) to operate truck bed.

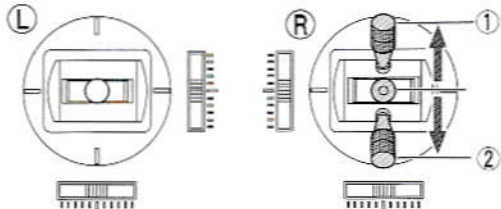

● Mistakes during teaching, or setting reverse switches to REV. position can cause the model to operate opposite to commands.

《When using MFC-03》

※ Start engine using procedure for 3ch engine start.

※ Truck bed cannot be moved when model is in simulated engine stop, or engine has not yet been started.

※ Select support leg mode using procedure for 4ch special (Support leg/Horn switching) via transmitter.

● Set MFC unit to multi mode. If using R/C mode, follow instructions for using with ESC.

※ 3 speeds are available, according to transmitter control stick position.

- ① Raising truck bed
- ② Lowering truck bed

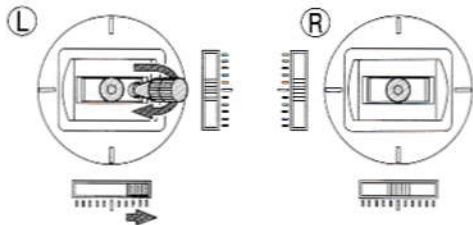

4ch special (Support leg/Horn switching)

Slide 4ch trim lever completely to the right. Fully push the stick to the right then return to neutral to switch function.

Hazard lamps will flash to show support leg mode (ACU-01 Unit) selection.

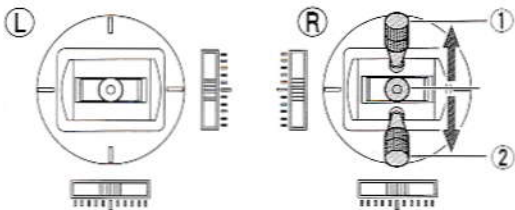

● Mistakes during teaching, or setting reverse switches to REV. position can cause the model to operate opposite to commands.

《Attaching units》

★Do not secure any motor cables and Ch.3 input cables together, as this will cause malfunction.
 ※Separately sold LEDs for connection to J5 and J6 are optional. Attach as you like.

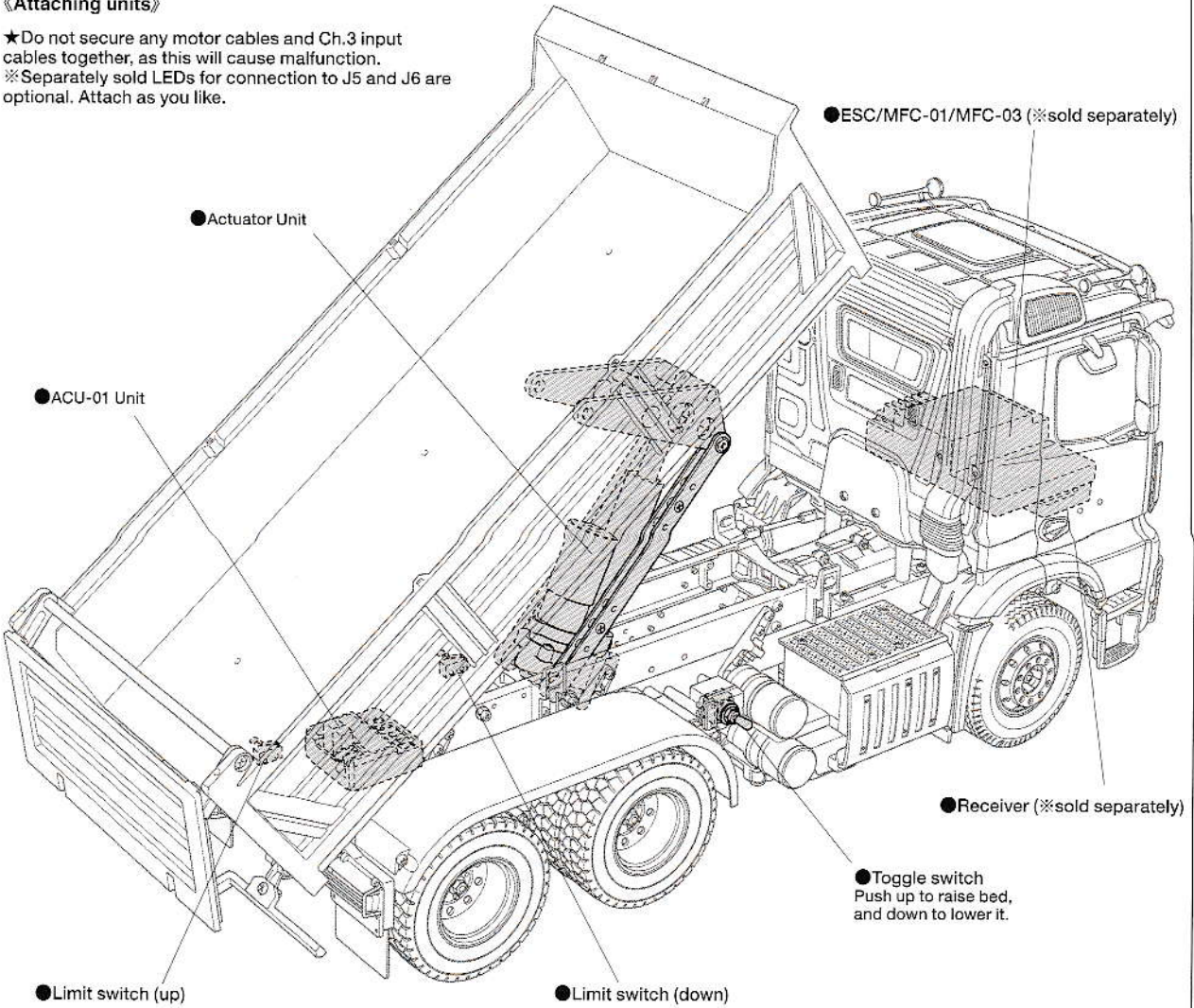

《Cables》

- Hold cables with nylon band and wire stickers.
- Do not hold ACU motor cables together with other cables. Frequency disturbance caused by contacting cables may lead to loss of control.
- If your receiver has an antenna cable, do not hold it together with other cables.

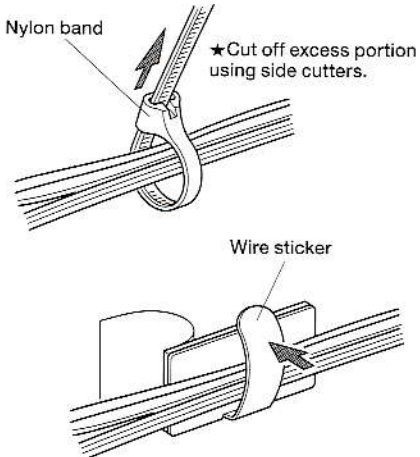

《Stick guide》

- Use stick guide to ensure correct transmitter commands.

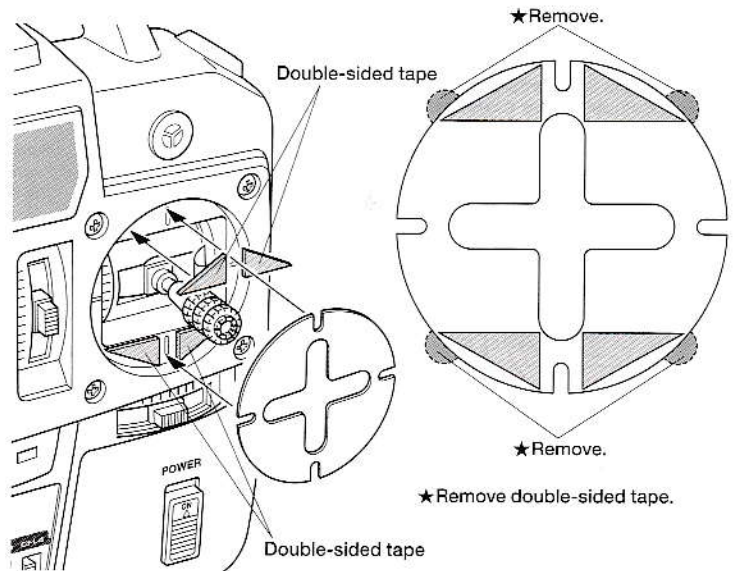

《LEDs》

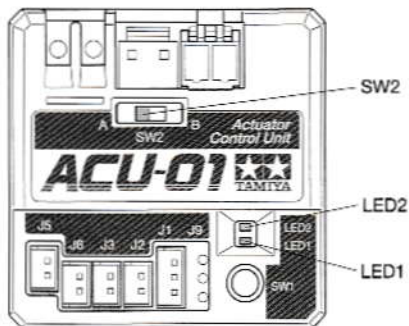

《When unit is turned on》

※When power supply is first connected and without SW1 pressed, LED 1 (J5) and LED 2 (J6) will flash in the patterns below for a set time.

●Standard mode (Tamiya battery pack)



●R6/AA/UM3 battery mode

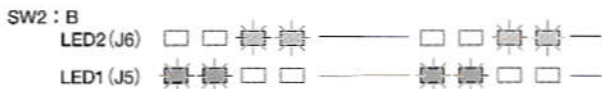

●Battery failsafe mode

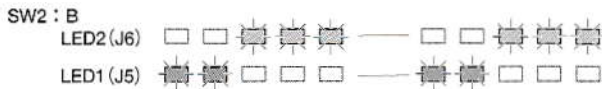
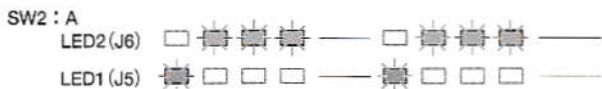

《After changing power mode》

※After power mode is changed and without SW1 pressed, LED 1 (J5) and LED 2 (J6) will flash in the patterns below for a set time.

●Standard mode

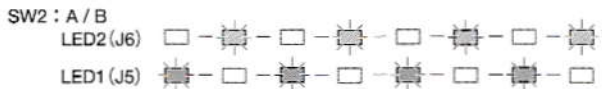

●R6/AA/UM3 battery mode

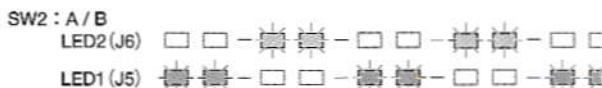

●Battery failsafe mode



《Errors (ACU-01 not operational)》

SW2 : A / B

●General use



★The ACU-01 unit will not operate when LEDs flash as shown below.

●Excessive current to FET



●FET overheating



●High battery voltage

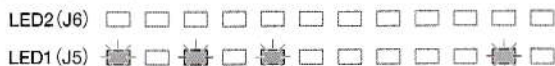

●Low battery voltage (not operational and alarm ② sounds)



●Very low battery voltage (ACU-01 stopped)



●Flash memory error (★Contact your local Tamiya dealer.)



《Errors (ACU-01 operational)》

SW2 : A / B

●Emergency stop (object trapped)

(★Bed can be lowered again after 10 seconds.)

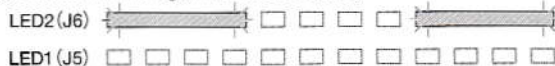

●Motor overload stop (lowering bed)

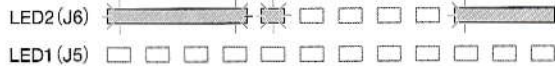

●Motor overload stop (raising bed)



●Low battery voltage (ACU-01 operational, alarm ① sounds)

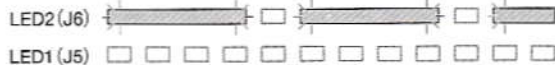

●Transmitter signal unstable/error



★If problems are not solved after following solutions on page 20 and allowing some time, please contact your local Tamiya dealer.

《Troubleshooting》

Problem	LED	Cause	Solution
Model does not move.	LEDs do not light up.	Battery is not charged.	Charge battery in model.
		ACU-01 Unit is broken.	Request repair service.
Truck bed does not move.	LEDs flash.	Insufficient battery charge.	Fully charge battery in model.
		Teaching error.	Re-initialize unit.
		Too much electric current for motor.	Check that motor is correct type.
			Check motor has not short-circuited.
			Adjust bed load, then disconnect and reconnect battery or use toggle switch to cancel protection function.
		Actuator FET overheating protection activated.	Switch off and check for obstructions to moving parts. Allow to cool for about 10 minutes.
		ESC/MFC-01/MFC-03 is not turned on.	Turn on.
	No Ch.3 signal from transmitter.	Select switch is on Manual Mode (MFC-01) or Demo Mode (MFC-03). Move to another position.	
	Transmitter power is not on.	Check transmitter.	
	LEDs are on.	Engine start not performed (MFC-01/MFC-03).	Perform engine start.
		Motor is broken.	Exchange motor for a new one.
		No Ch.3 signal from transmitter.	Miswiring. Reconnect cables.
			Engine is stopped (MFC-01/MFC-03). Perform engine start.
		Limit switch is broken.	Exchange for a new one.
Transmitter/receiver is broken.		Check without ESC/MFC-01/MFC-03 connected. If they still do not function, contact manufacturer for repair.	
Transmitter and receiver not communicating correctly.		Move motor cables away from antenna cable.	
Teaching error.	Check frequency band (non-2.4GHz units) and pairing.		
Truck bed movement is erratic.	LEDs flash.	Obstruction in moving parts.	Remove obstruction.
		Low battery voltage.	Fully charge battery in model.
		Truck bed load is too heavy.	Do not load truck bed over stated limit.
	LEDs are on.	Teaching error – raising/lowering of truck bed is opposite.	Re-do teaching.
		Cables are pinched.	Secure cables with nylon band.
LEDs flash.	LEDs flash.	ACU-01 Unit circuit board is damaged.	Request repair service.
Unit does not operate correctly.	LEDs are on.	Using transmitter/receiver set other than those recommended.	Use recommended transmitter/receiver set.
		Limit switch cable is broken.	Exchange limit switch for a new one.

- ★ Sudden throttle motion or starting on a hill with fully-loaded bed may cause a sudden drop in battery voltage and cause operation to stop.
- ★ If an object is trapped, the ACU-01 will detect excessive current and stop. Move bed in the opposite direction.
- ★ Switching immediately from raising bed to lowering (and vice versa) may cause the ACU-01 to act as if an object is trapped. Do not run continuously as it can damage unit and motor.
- ★ Attempting to move a loaded bed while the truck is moving can lead to a sudden drop in battery voltage and cause operation to stop. Avoid aggressive throttle use in particular.
- ★ If model stops suddenly, first check whether ACU-01 is still operational (i.e. bed moves), and reconnect battery if it is not. Turning

- MFC unit off and on does not reset ACU-01 protection function.
- ★ LEDs will continue to show an error until it is fixed, even if another error occurs afterwards. If errors are still shown despite successfully following the prescribed remedy, disconnect battery and restart.
- ★ Actuator motor speed may vary according to battery voltage.
- ★ Some ESCs do not have low voltage protection. In such a case, the ACU-01 protection functions will stop it before ESC cut-off if in standard mode.
- ★ Lowering loaded bed can cause protection function to operate and operation to stop. Toggle switch operation will be given priority over transmitter.

《Caution》

- Always disconnect battery after use, to avoid over-discharging.
- Only for use with Tamiya 7.2V or 6.6V battery packs. Batteries with higher voltage may damage the ACU-01 and MFC units.
- Refrain from aggressive use of throttle or long-lasting movement of truck bed.
- Avoid repeated, continuous raising and lowering of the truck bed, as this can cause overheating and damage to circuit board.
- Do not load truck bed over stated weight limit, as this can cause damage to moving parts, or ACU-01 overheating protection to activate.
- Do not touch or allow others to touch the model while the truck bed is moving – risk of injury.
- Connect cables correctly. Make sure connectors are always securely connected.
- Hold cables with nylon band and wire stickers. Do not hold running motor cables together with other cables. Frequency disturbance caused by contacting cables may lead to loss of control.
- Exposed wires may lead to short-circuits. A built-in security circuit is designed to stop operation if a short-circuit is detected, but may not catch all problems. In case of damage, contact your local Tamiya dealer for repair.

- Large amounts of friction caused by rotating parts can overheat motor or circuit board. Apply grease to gears, bearings and other rotating parts regularly.
- Heavy truck bed loads can cause quick depletion of battery and stop model. Recharge battery or reduce truck bed load.
- Old or over-discharged batteries may not be able to power model. Recharge and discharge several times, or replace with new battery.
- Use only TR mighty-tuned motor, or Tractor Truck Option Parts series motors for truck model.
- Continuous use with overloaded truck bed causes strain on parts and may lead to activation of the protection function. This function will disengage after motor and other components cool down (around 10 minutes depending upon temperature, etc.)
- Do not use in dusty or sandy conditions.

